

## FURITEK TEGU 3S MAIN BOARD FOR AXIAL SCX24 WITH FOC TECHNOLOGY

### Features:

- Built-in ESC FOC 20A, LED controller, Bluetooth (optional)
- Support brushless DC and brushed DC motor (config via app, default is brushless)
- FOC technology for very low speed in crawler mode with brushless motor
- Work with external receiver
- Built in BEC 5V-1.5A
- Super easy to use programming via App on Android and IOS
- Firmware update available
- Real-time telemetry up 10Hz
- Support 2S LiPo

### Specifications:

- Dimension (mm): 30.6(L)x30.6(W)
- Weight: about 5.2g
- Voltage support: 2s-3s lipo
- Motor type: Sensorless Brushless DC / Brushed DC
- BEC output: 5V/2A
- Const Current (A): 20A
- Burst Current (A): 40A

### Pinout:

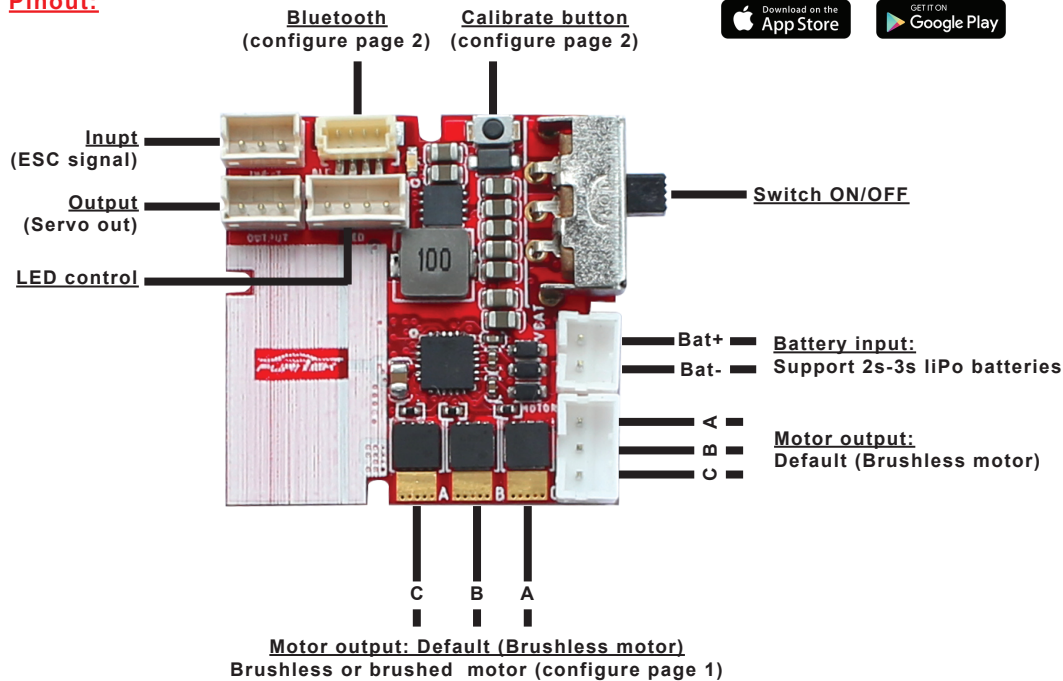

\*The "Servo" and "LED" port does not support in this version.

### Connect Brushed/Brushless motor to ESC:

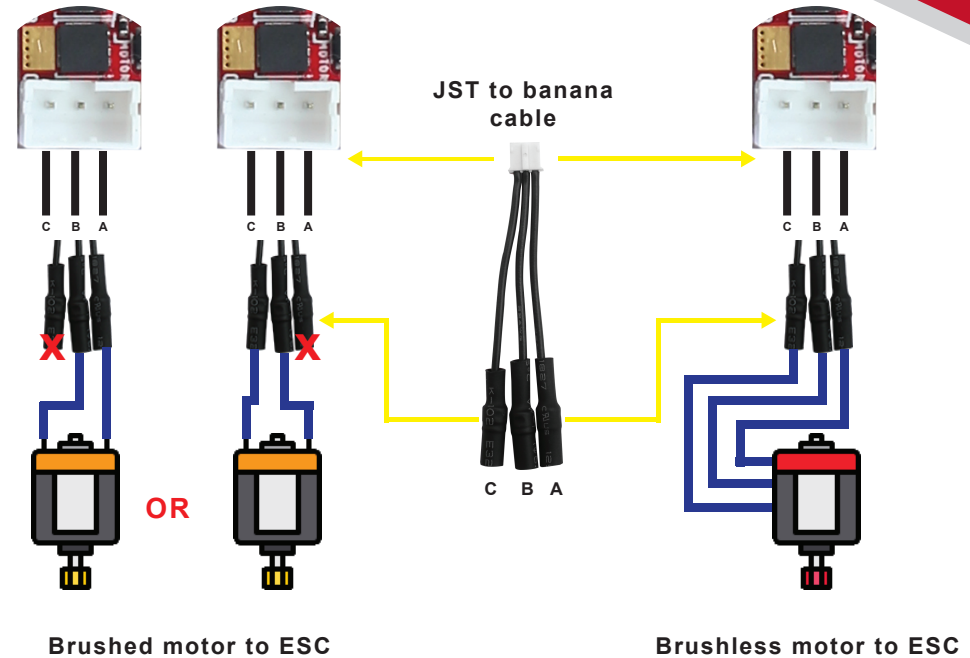

**\*DEFAULT configuration is Brushless motor, if you use BRUSHED motor, please configure it as below:**

- **Step 1:** Please make sure to plug your battery to esc and open FURICAR app on android or IOS device
- **Step 2:** Please Click the Setting icon (see picture)
- **Step 3:** Please click "Motor Type" menu, a new window pops up, select "Brushless" or "Brushed" and then click "OK"

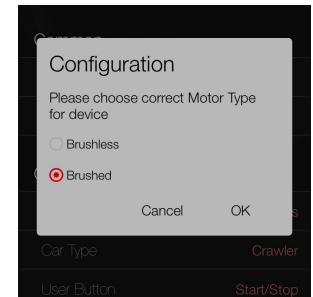
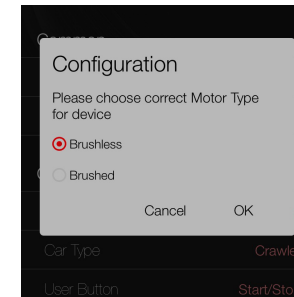
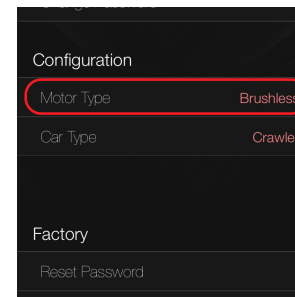

## Bluetooth:

- Default password to connect via Bluetooth "1234"

## \*Change password:

- **Step 1:** Please make sure to plug your battery to esc and open FURICAR app on android or IOS device

- **Step 2:** Please Click the Setting icon (see picture)



- **Step 3:** Please Click "Change Password" menu, a new window pops up, type your new password and then click "OK"

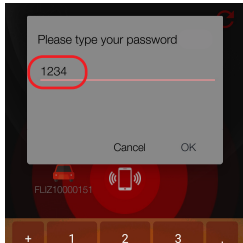

Default password:  
1234

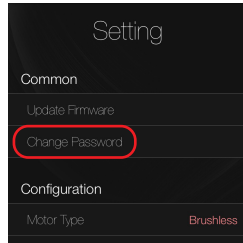

Change password

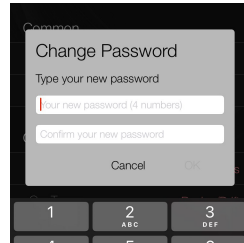

## Esc Manual calibration:

### A.Calibration on ESC Mainboard:(Do not use for Tegu with case and waterproof)

- **Step 1:** Please make sure to plug the battery to your esc
- **Step 2:** Press and hold the button of ESC (wait for 6 secs and the ESC LED indicator will start blinking followed by a motor beeping sound)
- **Step 3:** Set to 0% Throttle or lowest speed (please make sure that your radio throttle stick at NEUTRAL POSITION, press the ESC button, ESC LED indicator will blink 1 time and motor will beep 1 time)
- **Step 4:** Set to 100% Throttle or Maximum speed (move your radio throttle stick FORWARD and press the ESC button, ESC LED indicator will blink 2 times and motor will beep 2 times)
- **Step 5:** Setting up of your BRAKE (move the radio throttle stick BACKWARD and press the ESC button, ESC LED indicator will blink 3 times and motor will beep 3 times)
- **Step 6:** When your ESC show 4 blinking LED light and your motor beep 4 times mean you successfully CALIBRATED your Furitek ESC

### B.Calibrattion via App: (Your esc need a Bluetooth to communicate with app)

- **Step 1:** Please make sure to plug your battery to esc and open FURICAR app on android or IOS device
- **Step 2:** Please click "MENU" and click "THROTTLE"
- **Step 3:** Please click "CALIB" and then click "YES"

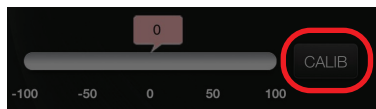
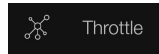

\*Follow intructions on the app screen till fishnish calibration

## Choose Channel2 to connect Receiver to ESC main board:

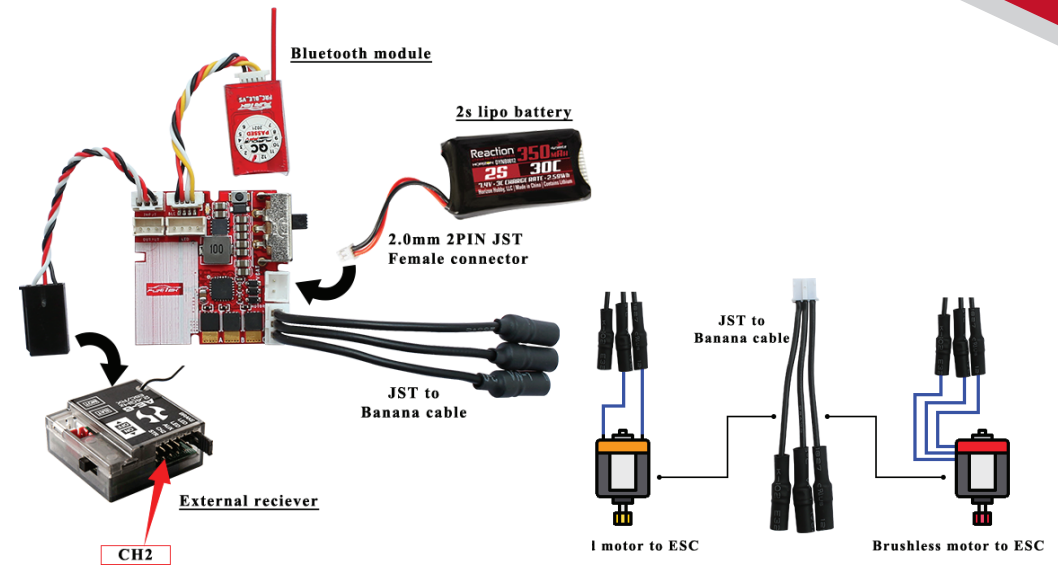

Connection Diagram for stock receiver/radio

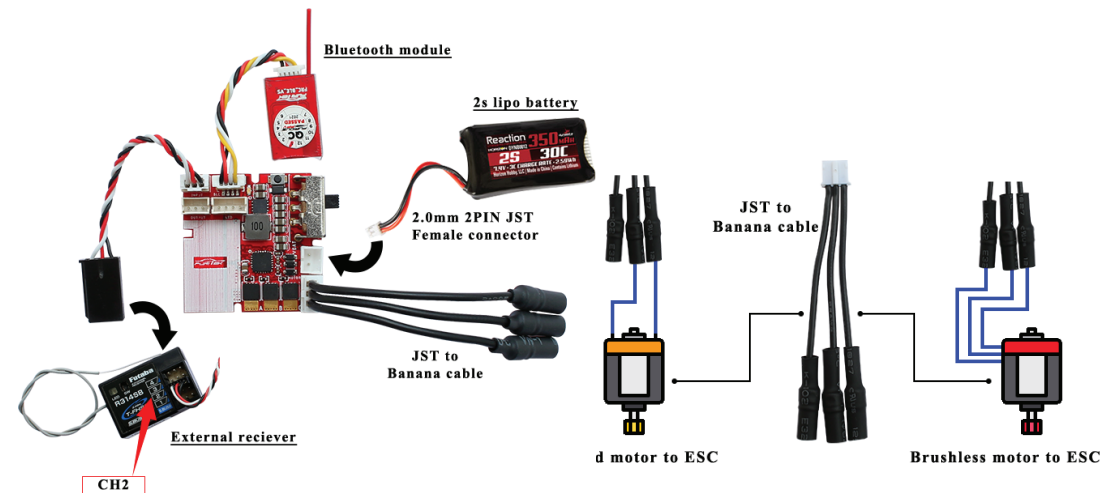

Connection Diagram for external receiver

